



Sainty Ultra wide folding door (ultra wide series 5m~ 15m)

Full name: Ultra wide heat insulation multiple double sealing folding door
(imported American hardware)



2-channel seal (patent)

Double-sided anti-clamp design (patent)

Hurricane resistant design



FOLDING DOOR SERIES

2 seal (patent)

Anti-clipping design (patent)

American AAMA Canadian CSA standard

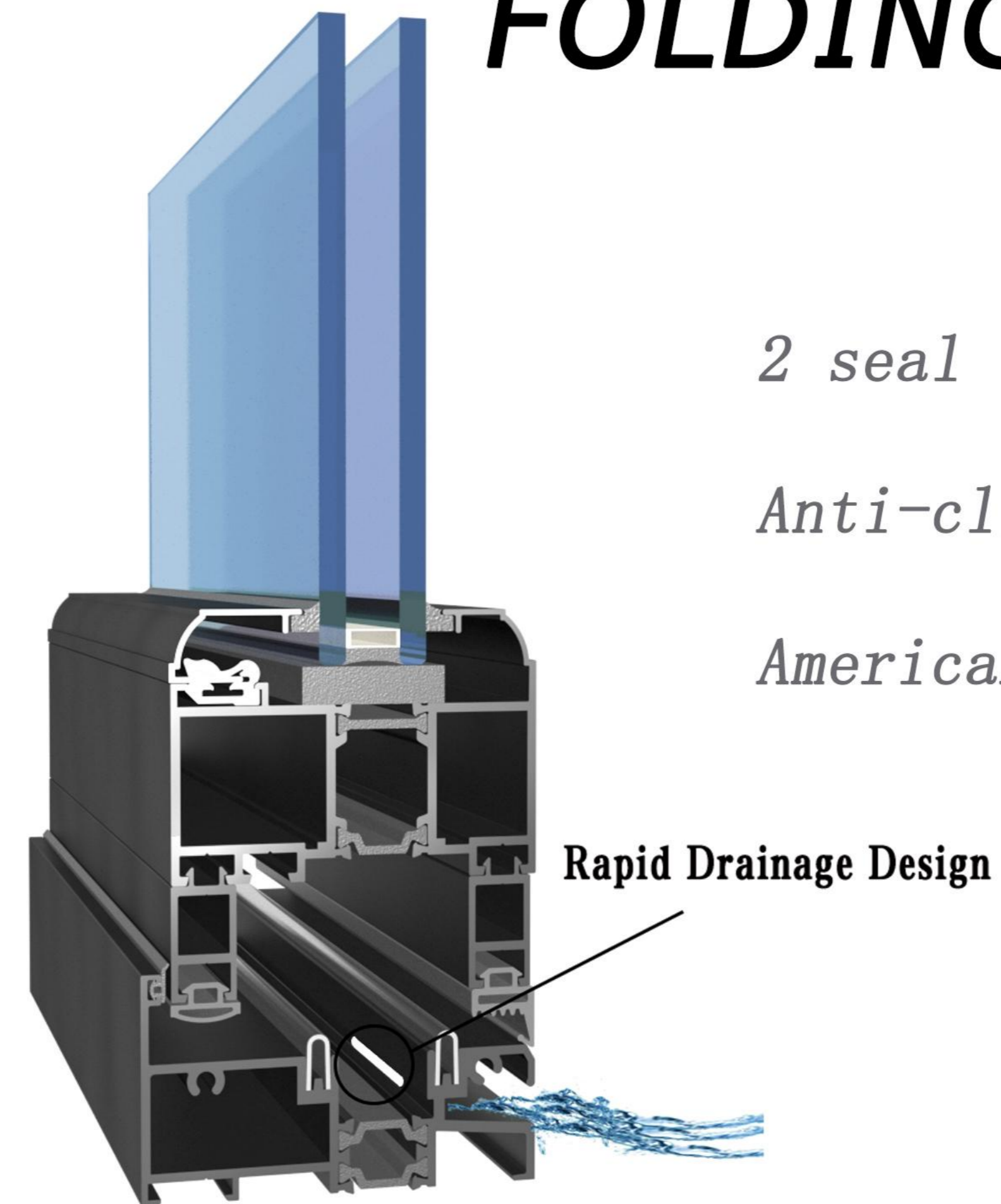

Double sealing

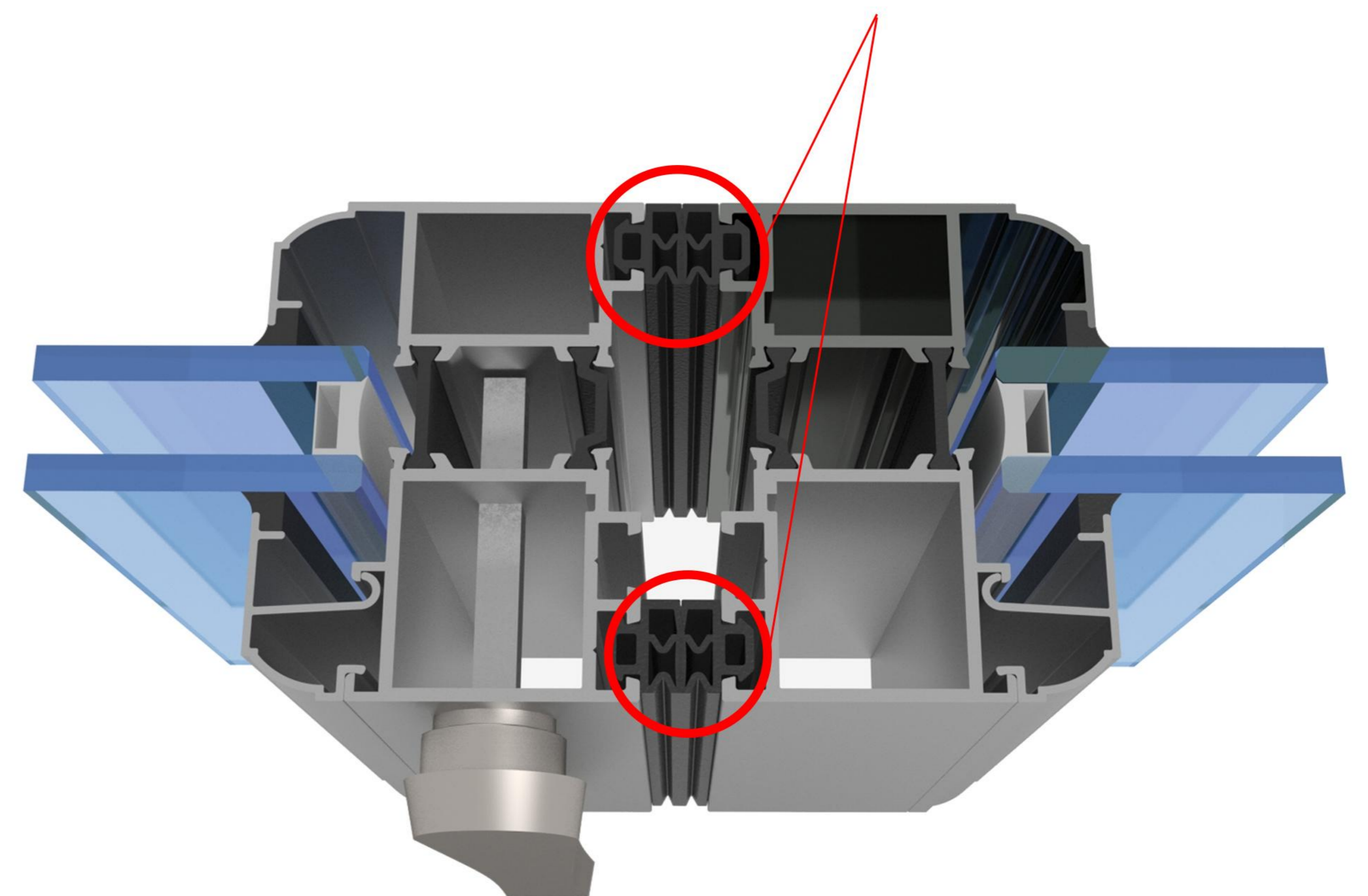

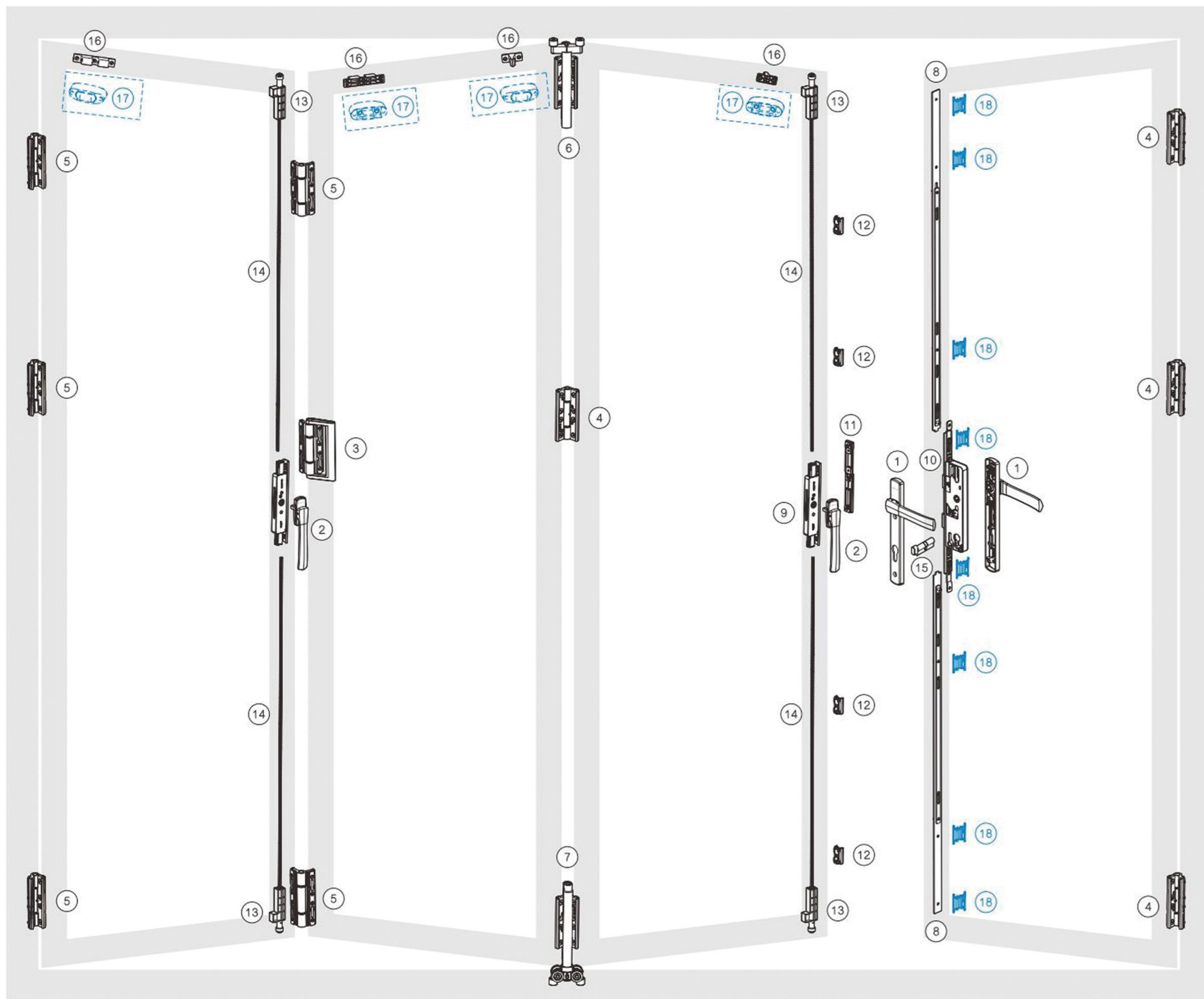

1



Double-sided flat handle

2



Single-sided flat handle

3



Handle hinges

4



Adjustable hinge

5



Non-adjustable hinge

6



Up track guide pulley

7



Lower rail bearing pulley

8



Roller type anti-lock point drive lever

9



Unidirectional double stroke square shaft driver

11



Adjustable lock seat

13



Latch

14



Latch connecting screw

16



Clasp type anti-collision gear

17



Magnetic anti-collision shield

18



Drive rod back plate

配置方案

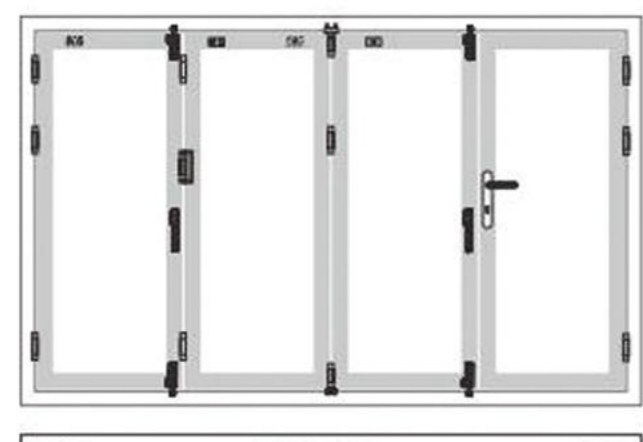

431配置

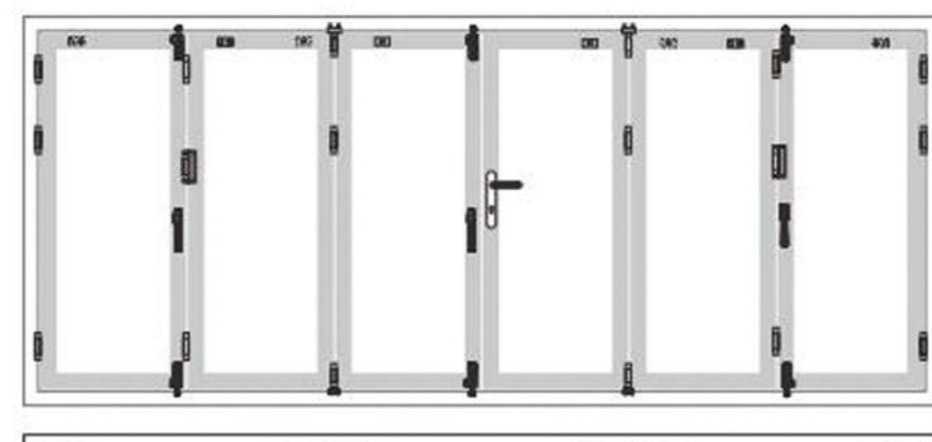

633配置

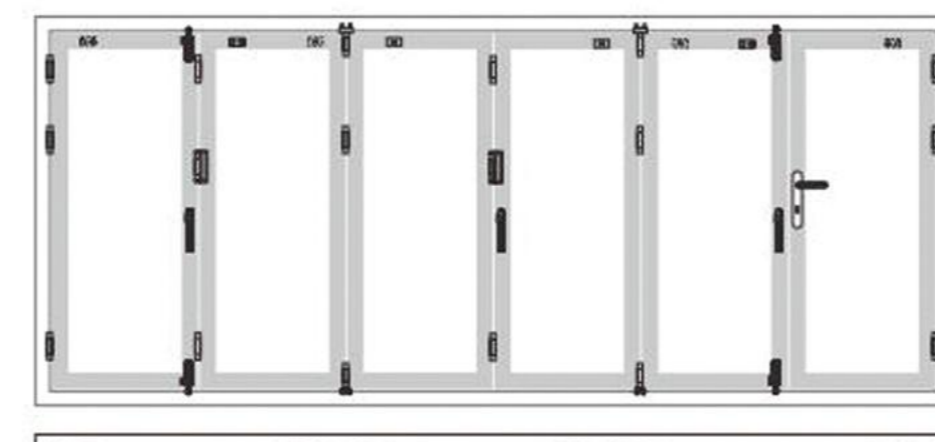

651配置

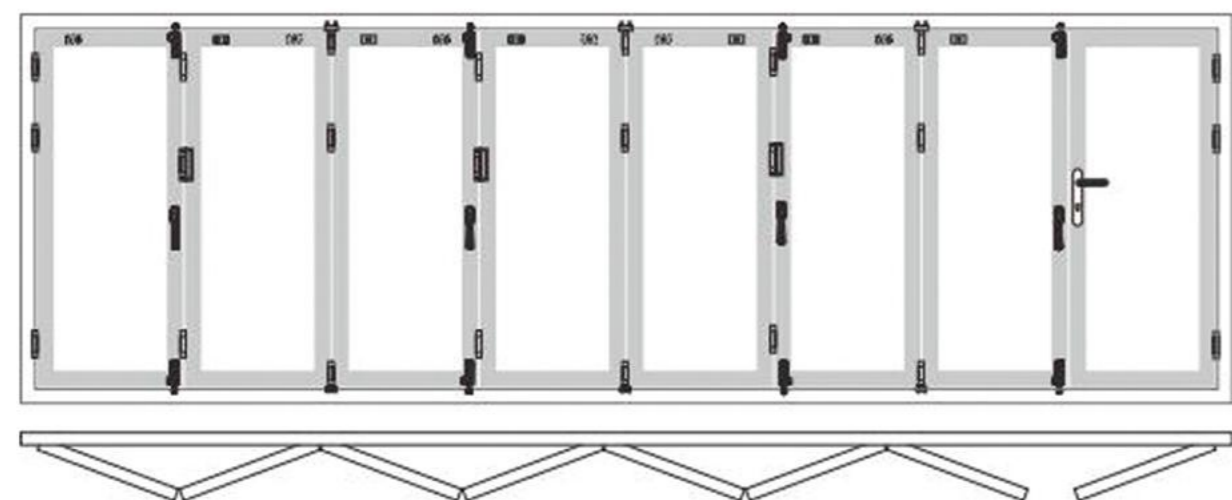

871配置

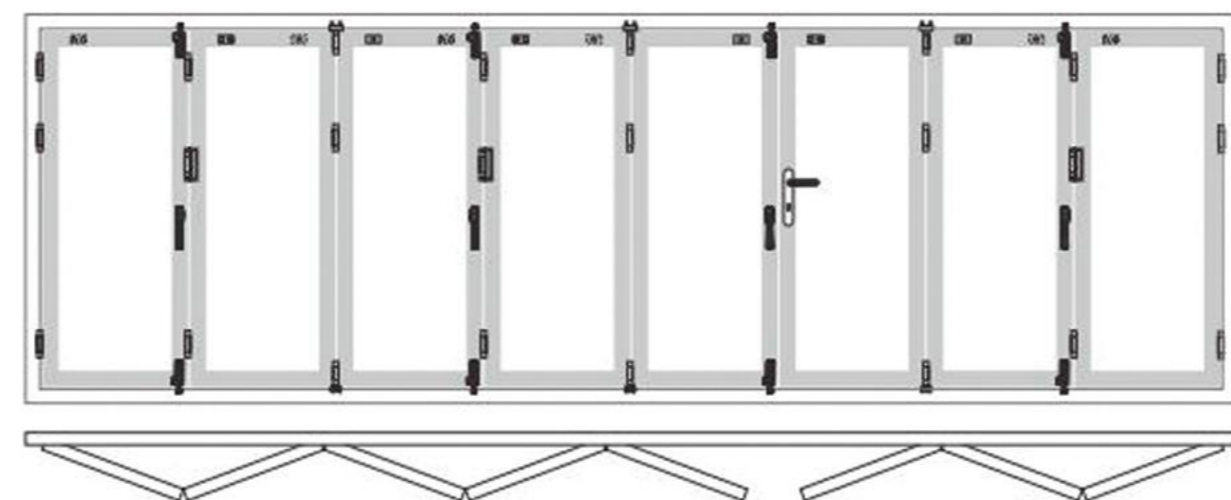

853配置

FOLDING DOOR SCREEN

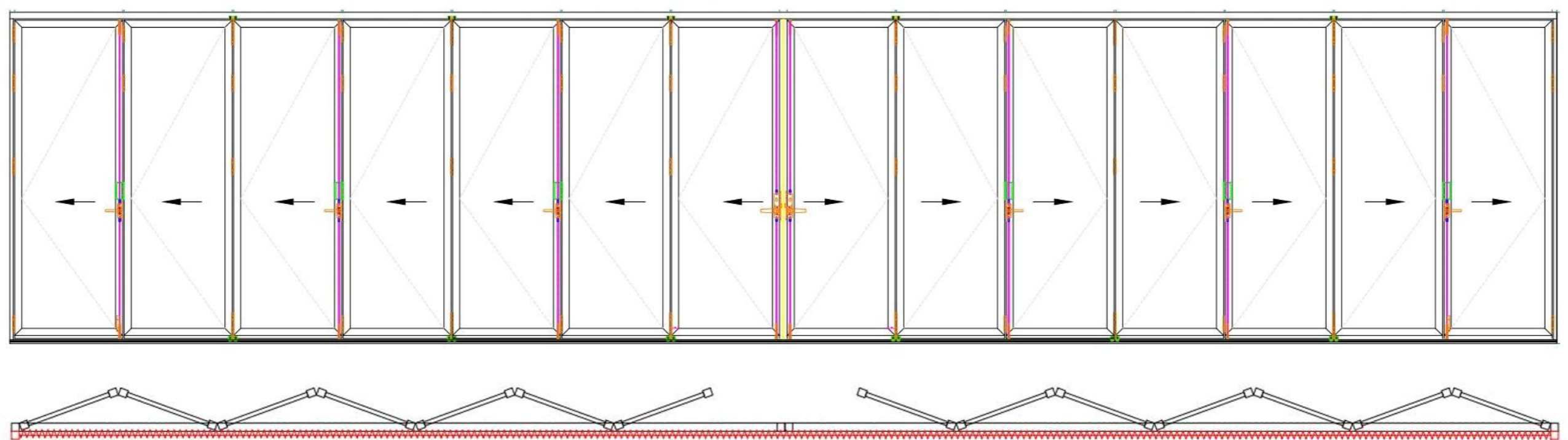

inside